

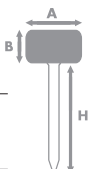





ACCESSORI
ACCESSORIES
ZUBEHÖRE
ACCESSOIRES
ACCESORIOS







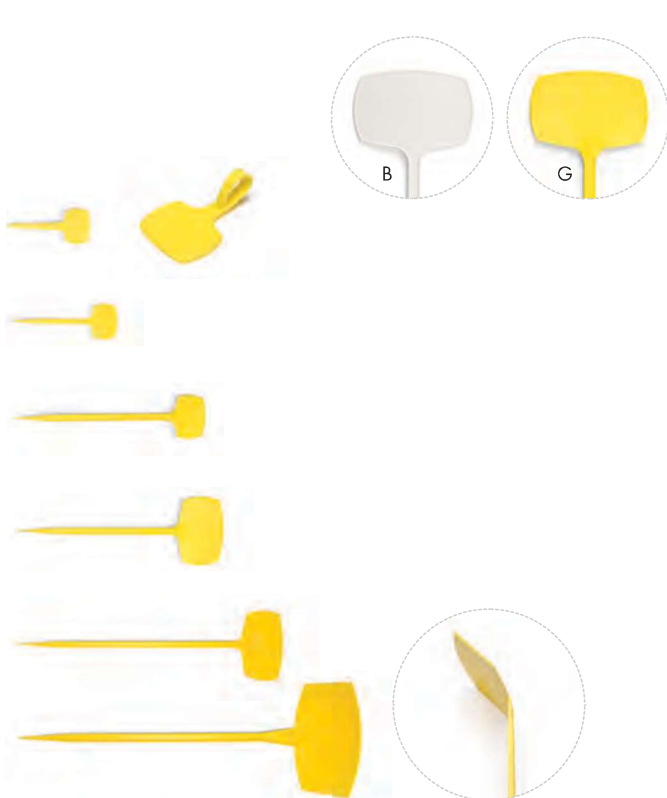

ETICHETTA

COD.		A x B	
50 PCS	910	bivalente - bivalent	5,3 x 4 x 8 h. 
	912	verticale - vertical aufrechte	5,3 x 4 x 11 h. 
	925	verticale - vertical aufrechte	6,5 x 4,5 x 24 h. 
10 PCS	930	verticale - vertical aufrechte	10 x 7 x 24 h. 
10 PCS	935	inclinata - tilted geneigt - incliné	10 x 7 x 35 h. 
	945	inclinata - tilted geneigt - incliné	16 x 10 x 43 h. 



CARRELLO ROTONDO SILVER





Metallo verniciato a polveri - Powder coated metal - Pulverbeschichtetes Metall
Fer revêtu époxy - Hierro con recubrimiento en polvo

COD.	A x H	 cm.	
3 PCS	F0425	27 x 6,5 h.	25 
	F0430	32 x 6,5 h.	30 
	F0435	37 x 7 h.	35 
	F0440	42 x 7 h.	40 
	F0450	52 x 7,5 h.	50 



CARRELLO QUADRATO SILVER



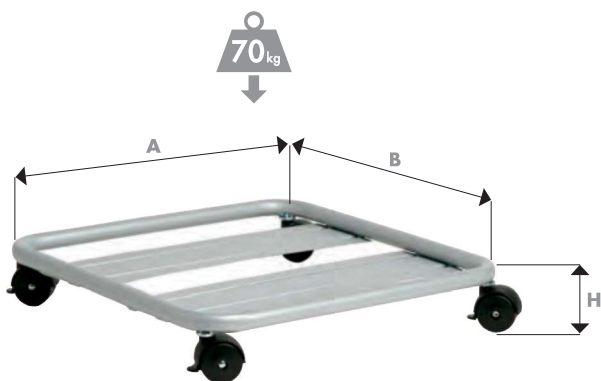

Metallo verniciato a polveri - Powder coated metal - Pulverbeschichtetes Metall
Fer revêtu époxy - Hierro con recubrimiento en polvo

COD.	A x B x H	 cm.	
3 PCS	F0522	27 x 27 x 6,5 h.	23 x 23 
	F0529	33 x 33 x 6,5 h.	29 x 29 
	F0533	37 x 37 x 6,5 h.	33 x 33 



CARRELLO RETTANGOLARE SILVER

Metallo verniciato a polveri - Powder coated metal - Pulverbeschichtetes Metall
Fer revêtu époxy - Hierro con recubrimiento en polvo

COD.	A x B x H	 cm.	
3 PCS	F0660	60 x 30 x 7,5 h.	55,5 x 25,5 
	F0680	76 x 36 x 7,5 h.	71 x 31,5 
	F06100	95 x 41 x 7,5 h.	90,5 x 36,5 

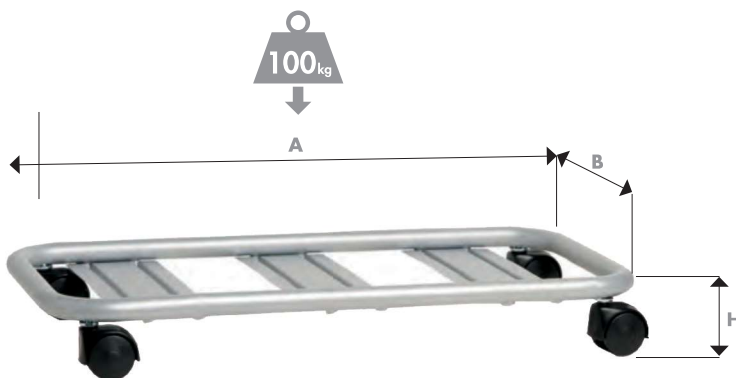

MATERIALE ESPOSITIVO

VISUAL MERCHANDISING - MARCHANDISAGE VISUEL
MERCHANDISING VISUAL



Contattate il vostro referente aziendale per le condizioni di fornitura

Contact your company representative for supply conditions

Kontaktieren Sie Ihren Firmenvertreter für die Lieferbedingungen

Contactez votre correspondant de la société pour connaître les conditions d'approvisionnement

Pida información a su representante para el suministro

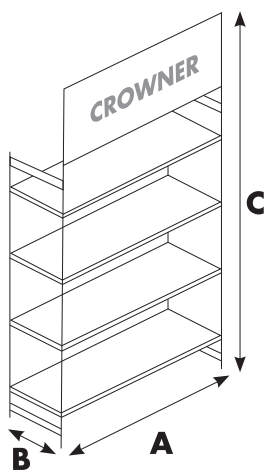

SCAFFALE - SCA 01

COD.	A x B x C
SCA01	120 x 60 x 250 h.

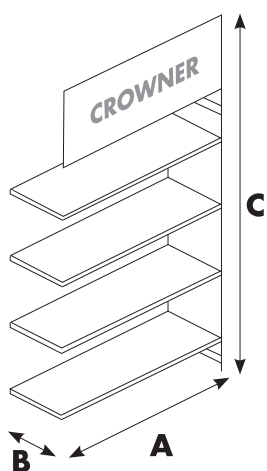

SCAFFALE - SCA 02

ABBINABILE A SCA01 - MATCHING WITH SCA01 - PASSEND ZU SCA01 -
COMBINABLE AVEC SCA01 - SE COMBINA CON SCA01

COD.	A x B x C
SCA02	120 x 60 x 250 h.

PANNELLO - CROWNER COD. PAN 01

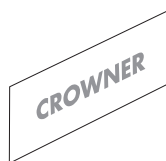

PANNELLO - CROWNER COD. PAN 02

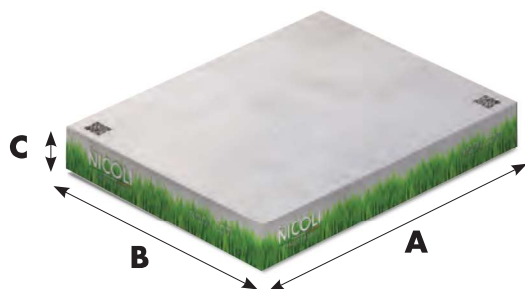

COPRI PALLET

COD.	A x B x C
COPRI	120 x 80 x 13 h.





NICOLI

Via del Lavoro, 10 - 36070 Brogliano (VI) - Italia
Tel. +39 0445 947344 - Fax +39 0445 947239
info@nicoli.com - www.nicoli.com

